

**PHILIPS**

**CATHODE-RAY TUBES**

*for measuring equipment*

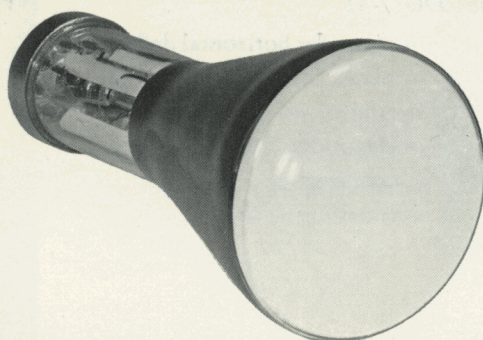
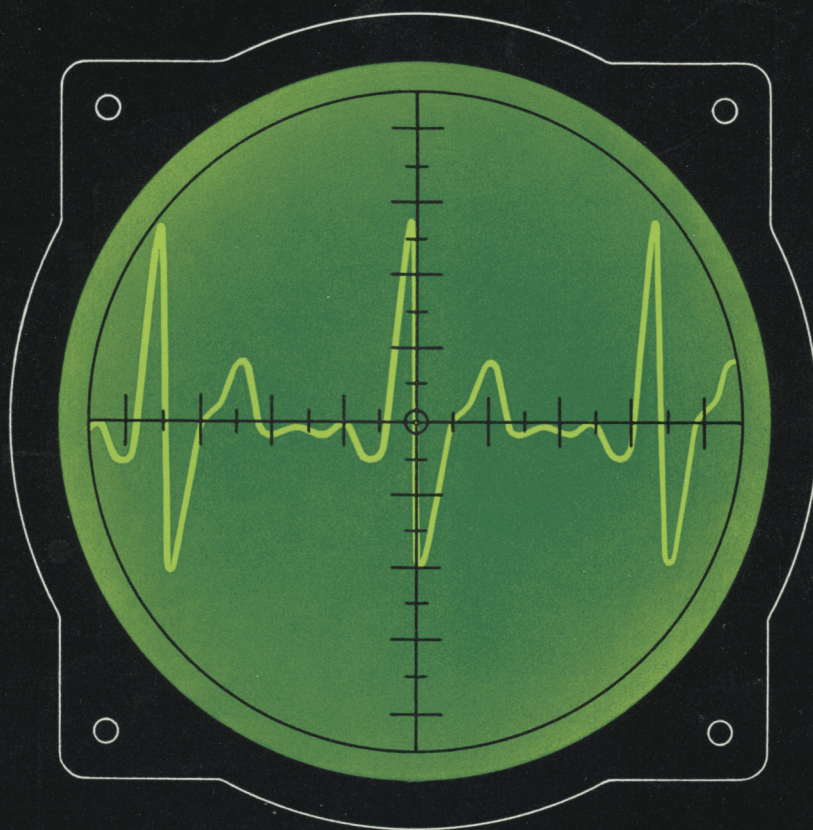

**LOW-VOLTAGE**

Cathode-Ray Tube

**DG 7-31**

PHILIPS ELECTRON TUBE DIVISION

# PHILIPS

## LOW-VOLTAGE INSTRUMENT CATHODE-RAY TUBE

### DG 7-31

- 400 V final anode voltage
- Deflection sensitivity 0.4 mm/V
- Small spot size, high brilliancy, excellent contrast
- Asymmetric deflection
- Overall length only 17 cm ( $6\frac{3}{4}$ " )

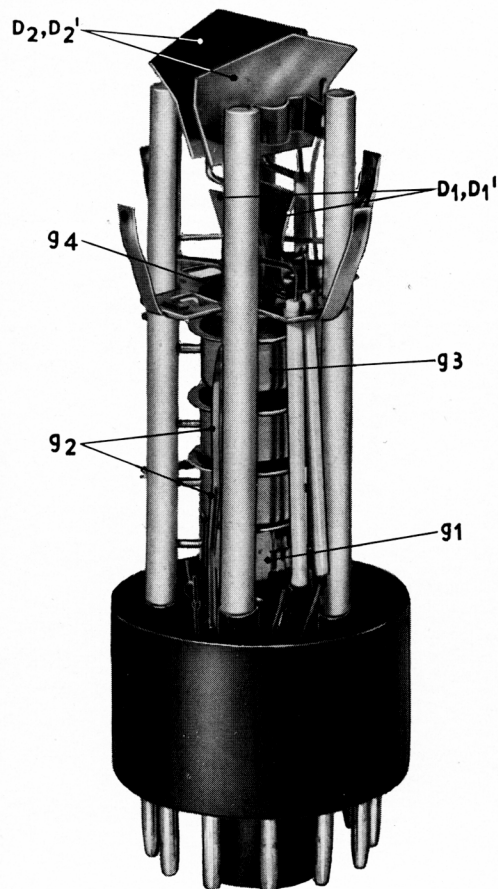

*Electron gun of the cathode-ray tube DG 7-31*

$D_2D_2'$  — plates for horizontal deflection.

$D_1D_1'$  — plates for vertical deflection

$g_1$  — control grid

$g_2, g_4$  — electrodes for pre-deflection acceleration

$g_3$  — focusing electrode

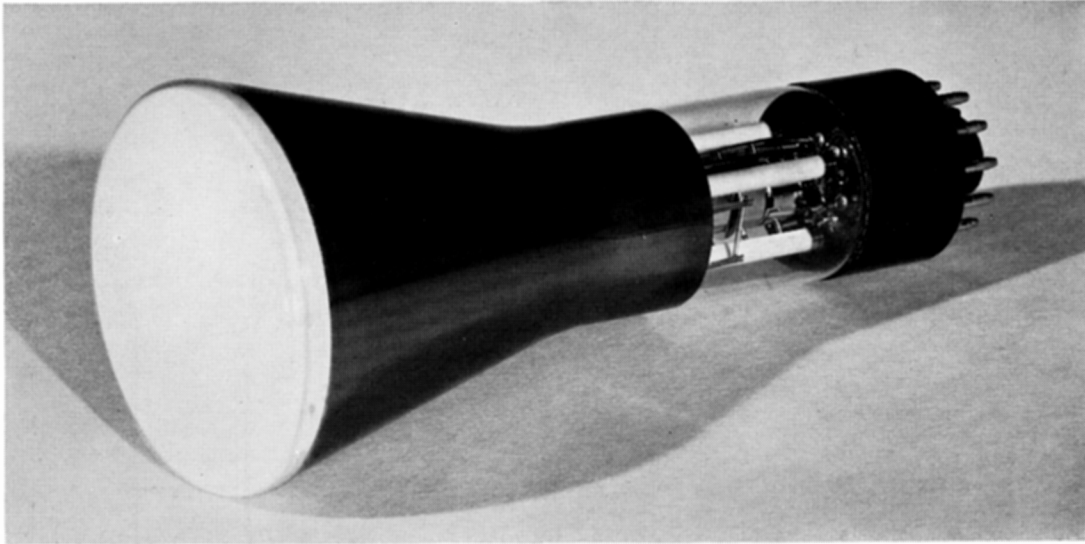

The DG 7-31 is a new type in our range of 7 cm (3'') cathode-ray tubes with characteristics making the tube particularly suitable for applications in low-cost, low-voltage, indicating instruments such as small, light-weight service oscilloscopes etc.

The type DG 7-31 has the following main features:

- Low anode voltage(400V) without screenburn or screencharge, thanks to the gun construction and a conductive layer placed in between the inner glass surface and the phosphor screen;
- High deflection sensitivity (0,4 mm/V) owing to the special design of the deflection plates;
- Asymmetric deflection; simplified design of the time base circuit;
- Fine and brilliant spot with a high contrast ratio;
- Overall length of only 17 cm (6<sup>3</sup>/<sub>4</sub>'').

The transparent, contrast improving and conductive layer between the face and the phosphor, being connected to the final anode, gives full protection against "electrostatic body-effect" even at high operation potential.

The fine characteristics of the tube render it very suitable for a wide range of applications in the indicating instruments field.

## ELECTRICAL DATA

### Screen

Fluorescence: green  
Persistence : medium

**Heating** indirect by a.c. or d.c.;  
series or parallel supply

Heater voltage . . . . .  $V_f = 6.3$  V  
Heater current . . . . .  $I_f = 0.3$  A

**Focusing** electrostatic

**Deflection** double electrostatic . . . . .  $D_1D_1'$  symmetric  
 $D_2D_2'$  asymmetric <sup>1)</sup>

**Line width** at  $V_{(g_2+g_4)} = 500$  V  
 $I_l = 0.5$   $\mu$ A . . . . . 0.5 mm <sup>2)</sup>

<sup>1)</sup>  $D_2$  has to be connected to  $g_2+g_4$   
<sup>2)</sup> Measured on a circle of 50 mm diameter.

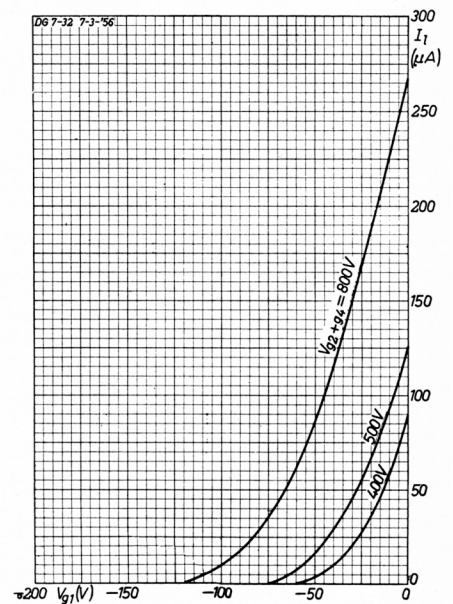

Screen current plotted against negative grid No 1 voltage

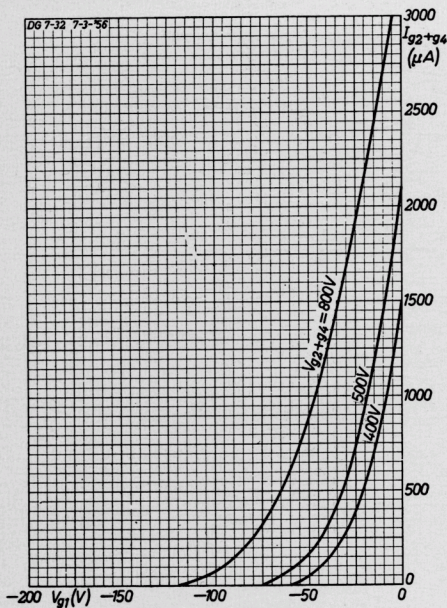

Final anode current plotted against grid cut-off voltage

| INTERELECTRODE CAPACITANCES |            |                   |
|-----------------------------|------------|-------------------|
| Electrodes                  | Symbol     | Cap. (pF)         |
| $D_1$ to $D_1'$             | $CD_1D_1'$ | 1.1               |
| $D_2$ to $D_2'$             | $CD_2D_2'$ | 1.8               |
| $D_1$ to all                | $CD_1$     | 2.5 <sup>1)</sup> |
| $D_1'$ to all               | $CD_1'$    | 2.5 <sup>1)</sup> |
| $D_2$ to all                | $CD_2$     | 3.4 <sup>1)</sup> |
| $D_2'$ to all               | $CD_2'$    | 3.0 <sup>1)</sup> |
| Grid 1 to all               | $C_{g1}$   | 7.6               |
| Cathode to all              | $C_k$      | 3.2               |

**Operating characteristics**

|   |                   |   |                       |
|---|-------------------|---|-----------------------|
| Grid No. 2 and grid No. 4 voltage . . . . .                           | $V_{(g_2 + g_4)}$ | = | 500 V                 |
| Grid No. 3 voltage . . . . .  | $V_{g_3}$         | = | 0-120 V <sup>2)</sup> |
| Negative grid No. 1 voltage for visual extinction of the focused spot | $-V_{g_1}$        | = | 50-100 V              |
| Deflection sensitivity . . . . .                                      | $D_2D_2'$         | = | 0.35-0.43 mm/V        |
| Deflection sensitivity . . . . .                                      | $D_1D_1'$         | = | 0.22-0.28 mm/V        |

**Limiting values** (design centre values)

|   |                   |   |                           |
|---|-------------------|---|---------------------------|
| Grid No. 2 and grid No. 4 voltage . . . . .     | $V_{(g_2 + g_4)}$ | = | max. 800 V<br>min. 400 V  |
| Grid No. 3 voltage . . . . .                    | $V_{g_3}$         | = | max. 200 V <sup>2)</sup>  |
| Grid No. 1 voltage (negative value) . . . . .   | $-V_{g_1}$        | = | max. 160 V                |
| Grid No. 1 voltage (positive value) . . . . .   | $+V_{g_1}$        | = | max. 0 V                  |
| Peak voltage on $D_1D_1'$ . . . . .             | $V_{D_1D_1'p}$    | = | max. 450 V                |
| Peak voltage on $D_2D_2'$ . . . . .             | $V_{D_2D_2'p}$    | = | max. 750 V                |
| Voltage between cathode and heater . . . . .    | $V_{kf}$          | = | max. 125 V                |
| Screen dissipation . . . . .                    | $W_l$             | = | max. 3 mW/cm <sup>2</sup> |
| Grid No. 2 and grid No. 4 dissipation . . . . . | $W_{(g_2 + g_4)}$ | = | max. 0.5 W                |

**Maximum circuit values**

|   |           |   |        |
|---|-----------|---|--------|
| Deflection plate circuit resistance . . . . . | $RD$      | = | 5 MΩ   |
| Grid No. 1 circuit resistance . . . . .       | $R_{g_1}$ | = | 0.5 MΩ |

**MECHANICAL DATA**

**Mounting position:** any

**Dimensions:** overall length 172 mm (6<sup>3</sup>/<sub>4</sub>"  
screen diameter 70 mm (3")

**Net weight:** 120 g (4.2 ounce)

1) Except the opposite deflection plate.  
2) For calculation of the grid 3 potentiometer a grid 3 current of min. -15 μA and max. +10 μA must be taken into account.

## G-screen

The green fluorescent G-screen provides high visual contrast under conditions of normal ambient illumination. It has medium persistence and can be used for visual observation of recurrent phenomena in the majority of applications.

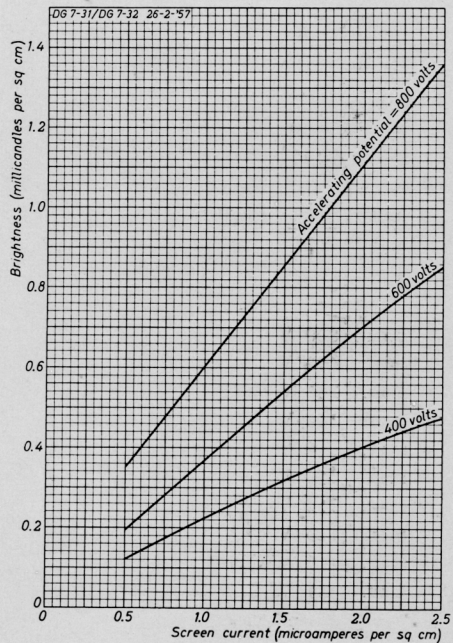

Relative spectral energy distribution of a G-screen.

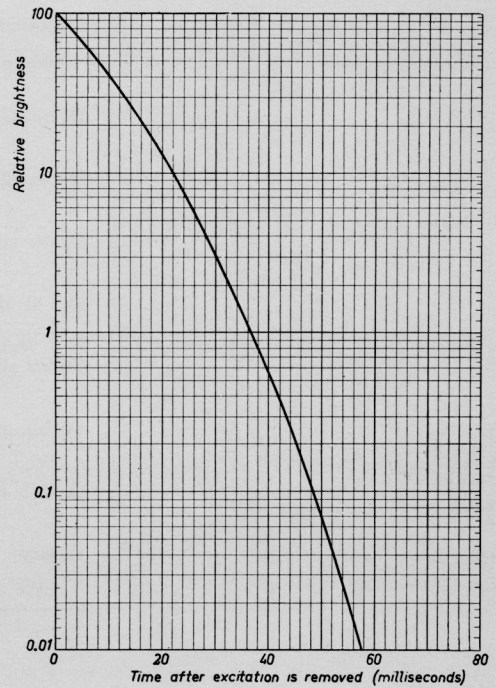
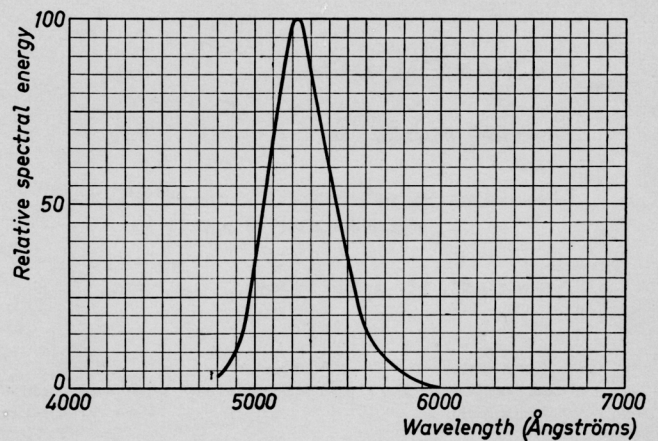

Persistence characteristic of a G-screen.

Brightness of a G-screen as a function of the screen current per square cm screen area, with the accelerating potential as a parameter.

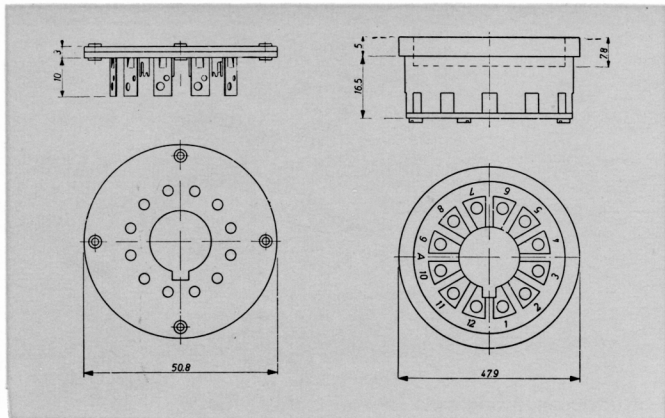

Base: duodecal 12-pins

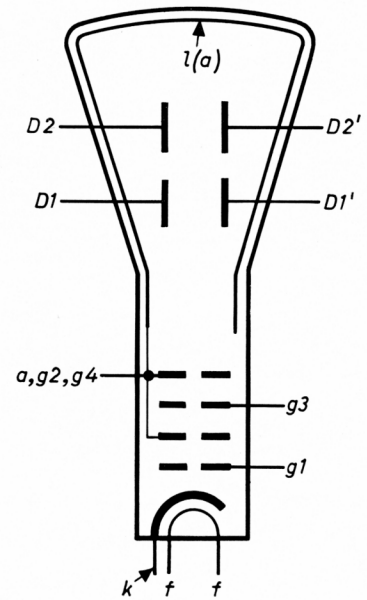

Electrode arrangement

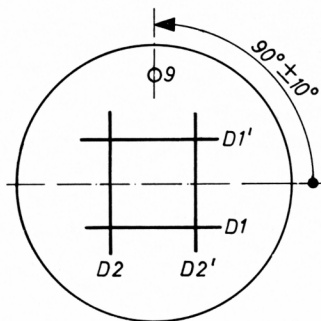

Position of the deflection plates

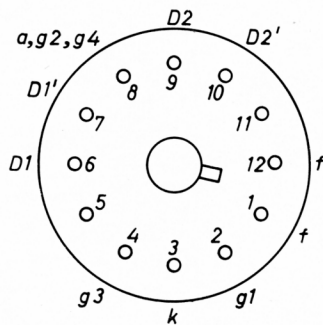

Base connections

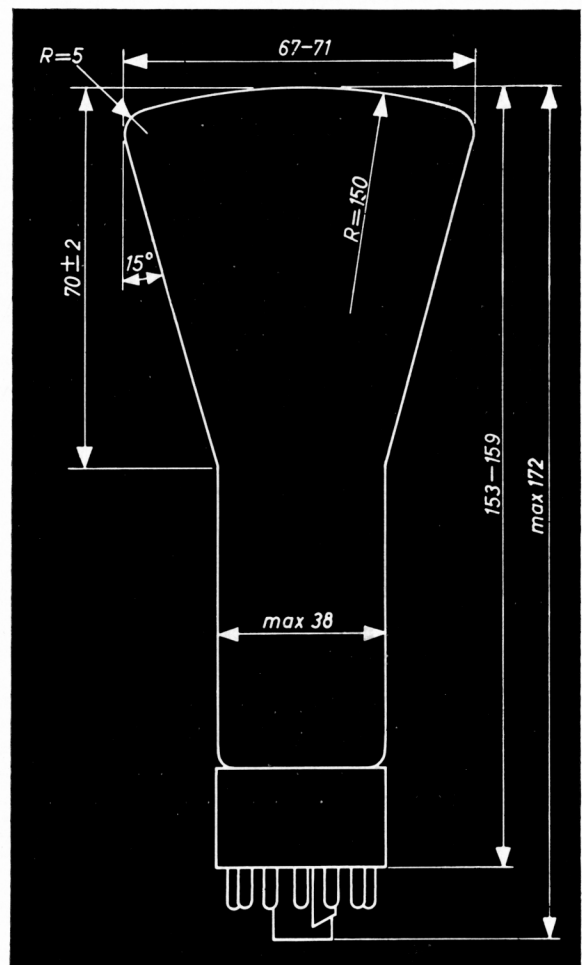

Outline drawing of the DG 7-31 (dimensions in mm)